



Since 1966

# Tubular Specialties Manufacturing, Inc.

13011 South Spring Street, Los Angeles, CA 90061-1685

Phone 800/Grab Bar (800/472-2227) or 310/515-4801

www.GrabBar.com • Fax 310/217-0653

# Series

# B-400

Bright Brass

## Brass Component Railing System

### Technical Data

Revised December 2007

Page 1 of 6

#### Bar Wall Bracket

Footrail bracket fastens to wall. Top flange has 5/16"-18 threaded mounting hole that requires either access from back or a 3/16" pilot hole about 1" deep to be used with a hanger bolt (supplied by others). Tubing fits inside circular sleeve.

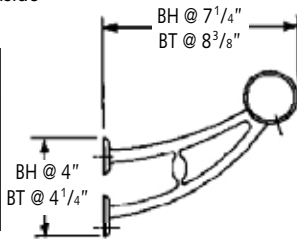

- BH-401 - 1 1/2"
- BT-401 - 2"

#### Bar Wall/Floor Bracket

Fastens to wall with two surface mounted screw holes; the other leg rests on the floor but is not screwed into it. Tubing fits inside circular sleeve.

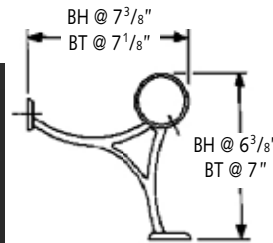

- BH-402 - 1 1/2"
- BT-402 - 2"

#### Bar Floor Bracket

Fastens to wall with two surface mounted screw holes. Tubing fits inside circular sleeve.

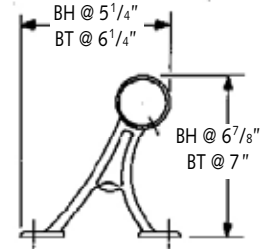

- BH-403 - 1 1/2"
- BT-403 - 2"

#### Bar Wall Bracket with Movable Leg

Filigreed footrail bracket fastens to wall with four screw holes. Movable leg swings up to facilitate cleaning. Tubing fits inside circular sleeve.

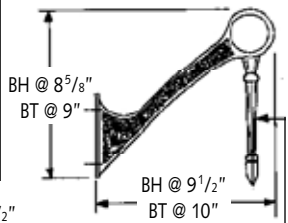

- BH-404 - 1 1/2"
- BT-404 - 2"

#### Arm Rail Bracket

Tubing fits inside circular sleeve bracket that fastens to underside of bar with two screw holes.

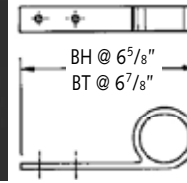

- BH-405 - 1 1/2"
- BT-405 - 2"

#### Wall Bracket, Rounded

Fastens to wall with two surface mounted screw holes. Tubing fits inside circular sleeve.

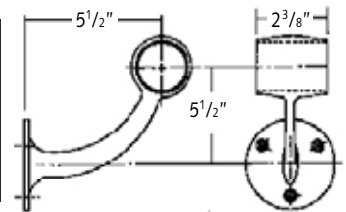
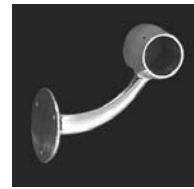

- BT-420G - 2"

#### Center Post

Has two surface mounted screw holes. Tubing fits inside circular sleeve.

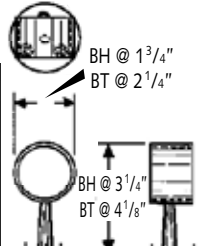

- BH-424 - 1 1/2"
- BT-424 - 2"

#### Rounded Center Post

Has two surface mounted screw holes. Tubing fits inside circular sleeve.

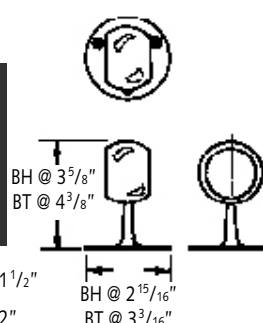
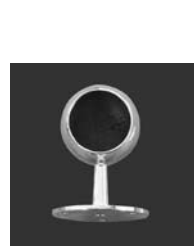

- BH-424A - 1 1/2"
- BT-424A - 2"

#### Wall Saddle Bracket

Fastens to wall with three surface mounted screw holes. Tubing attaches to bracket with set screws provided by TSM.

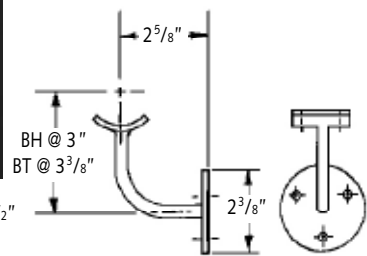

- BH-425 - 1 1/2"
- BT-425 - 2"

Manufacturer reserves the right to alter design or dimensions without formal notice and without incurring obligation.

© 2007, Tubular Specialties Mfg., Inc. All Rights Reserved



# Guarantee

TSM Series B-400 Brass Component Railing System is guaranteed against defects in workmanship and material for one year from shipping date.

**Wall Saddle Bracket, Large**

Fastens to wall with three surface mounted screw holes. Tubing attaches to bracket with set screws provided by TSM.

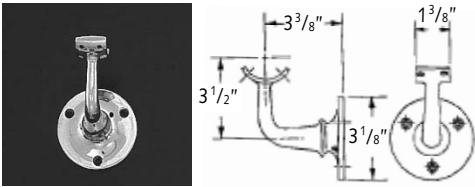

**BT-425G** - 2"

**Wall Flat Bracket**

Fastens to wall with three surface mounted screw holes. Tubing attaches to bracket with set screws provided by TSM.

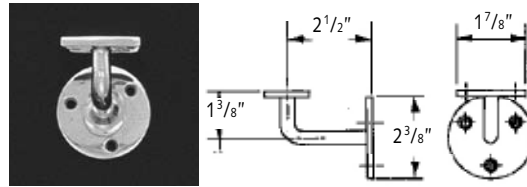

**BT-426** - 2"

**Side Mount Bracket**

Has four surface mounted screw holes. Tubing fits inside circular sleeve.

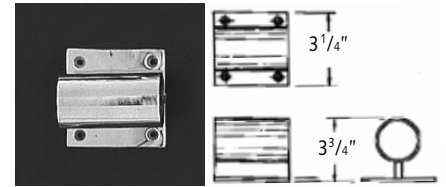

**BT-431** - 2"

**Bar Straight Floor Bracket**

Has two surface mounted screw holes. Tubing fits inside circular sleeve.

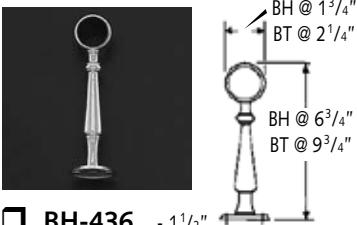

**BH-436** - 1 1/2"

**BT-436** - 2"

**Square Wall Bracket**

Fastens to wall with four surface mounted screw holes. Tubing fits inside circular sleeve.

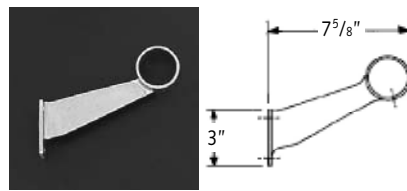

**BT-443** - 2"

**Flush Angle @ 135°**

Angle ends fit inside tubing.

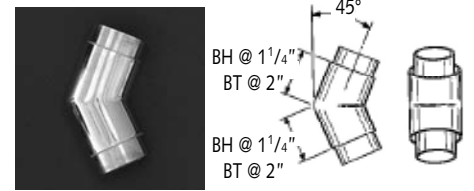

**BH-409** - 1 1/2"

**BT-409** - 2"

**Flush Elbow, Rounded**

Elbow ends fit inside tubing.

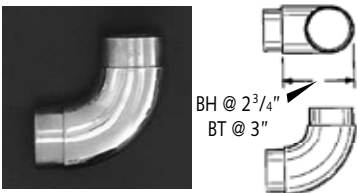

**BH-410** - 1 1/2"

**BT-410** - 2"

**Flush Elbow, Square**

Elbow ends fit inside tubing.

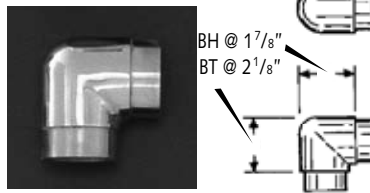

**BH-411** - 1 1/2"

**BT-411** - 2"

**Flush Elbow Side Outlet**

Elbow ends fit inside tubing.

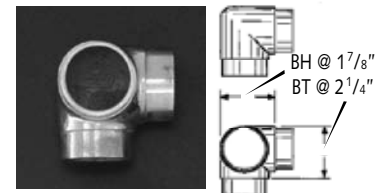

**BH-412** - 1 1/2"

**BT-412** - 2"

**Flush Tee Side Outlet**

Tee ends fit inside tubing.

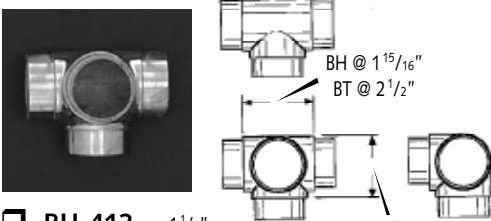

**BH-413** - 1 1/2"

**BT-413** - 2"

**Flush Tee**

Tee ends fit inside tubing.

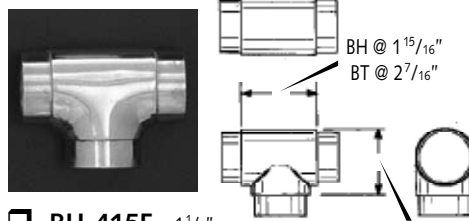

**BH-415F** - 1 1/2"

**BT-415F** - 2"

**Flush Cross**

Cross ends fit inside tubing.

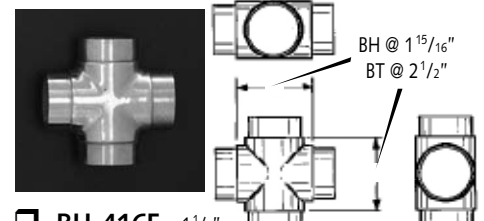

**BH-416F** - 1 1/2"

**BT-416F** - 2"

**Ball Elbow**

Elbow ends slip over tubing.

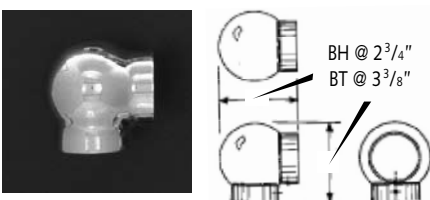

**BH-414** - 1 1/2"

**BT-414** - 2"

**Ball Tee**

Tee ends slip over tubing.

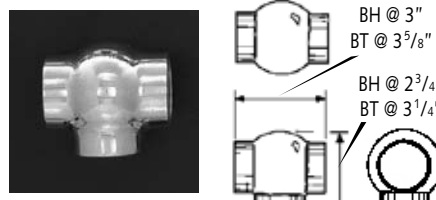

**BH-415** - 1 1/2"

**BT-415** - 2"

**Thru Center Ball**

Tubing fits through ball ends.

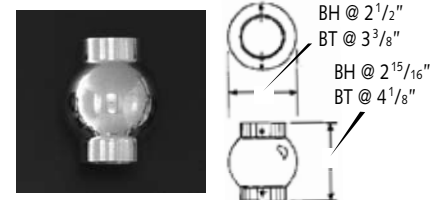

**BH-415P** - 1 1/2"

**BT-415P** - 2"

**Ball Tee Side Outlet 135°**

Tubing fits through ball ends with two 135° side connections.

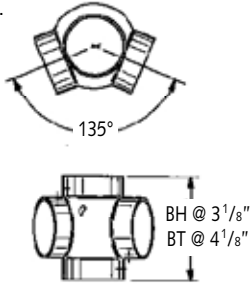

- BH-415S - 1 1/2"
- BT-415S - 2"

**Ball Cross**

Tubing fits through ball ends with two 90° side connections.

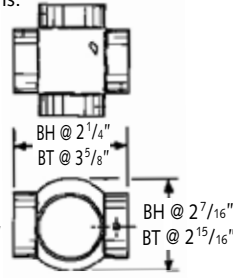

- BH-416 - 1 1/2"
- BT-416 - 2"

**Ball Elbow Side Outlet**

Elbow ends slip over tubing.

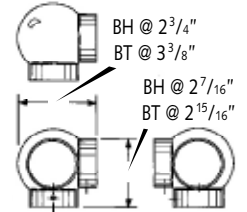

- BH-417 - 1 1/2"
- BT-417 - 2"

**Ball Tee Side Outlet**

Tubing fits through ball ends with 90° side connections.

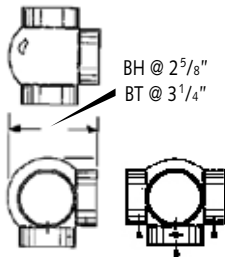

- BH-418 - 1 1/2"
- BT-418 - 2"

**Ball Cross Side Outlet**

Tubing fits through ball ends with two 90° side connections.

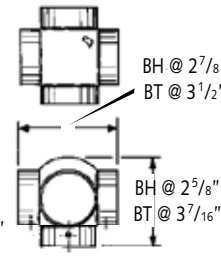

- BH-419 - 1 1/2"
- BT-419 - 2"

**Ball Elbow @ 135°**

Elbow ends slip over tubing.

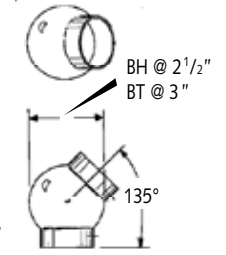

- BH-420 - 1 1/2"
- BT-420 - 2"

**Ball Elbow Side Outlet @ 135°**

Elbow ends slip over tubing.

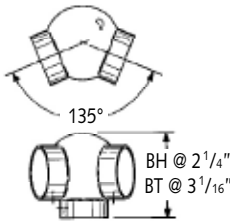

- BH-421 - 1 1/2"
- BT-421 - 2"

**End Scroll**

Scroll end fits inside tubing

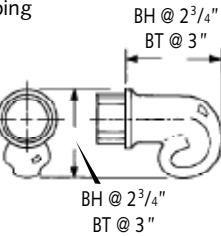

- BH-406 - 1 1/2"
- BT-406 - 2"

**Flat End Cap**

End cap fits inside tubing.

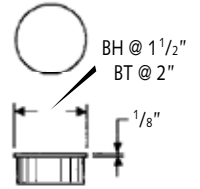
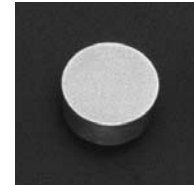

- BH-422 - 1 1/2"
- BT-422 - 2"

**Filigree End Cap**

End cap slips over tubing.

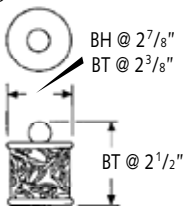

- BH-422A - 1 1/2"
- BT-422A - 2"

**Decorative End Cap**

End cap slips over tubing.

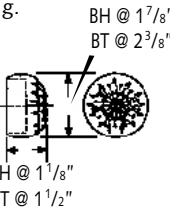
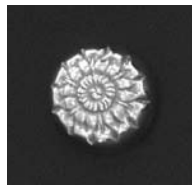

- BH-422K - 1 1/2"
- BT-422K - 2"

**Ball End**

Ball end slips over tubing.

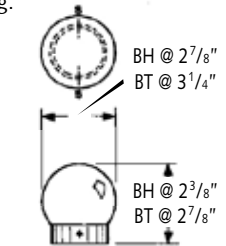

- BH-422L - 1 1/2"
- BT-422L - 2"

**Dome End Cap, Flush**

End cap fits inside tubing.

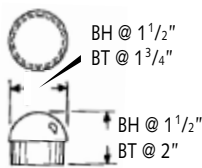

- BH-422R - 1 1/2"
- BT-422R - 2"

**End Post**

Tubing fits inside end post. Companion to 424 (p. 1).

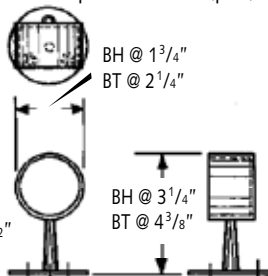

- BH-423 - 1 1/2"
- BT-423 - 2"

**Rounded End Post**

Companion to 424A (p. 1).

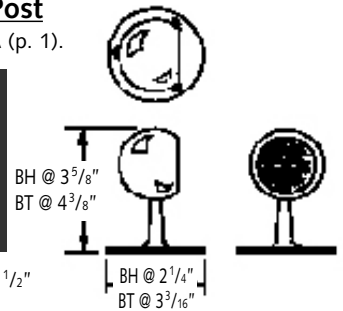
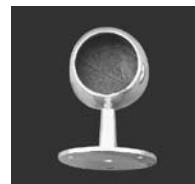

- BH-423A - 1 1/2"
- BT-423A - 2"

### Ball Finial

Finial ends fits inside tubing.

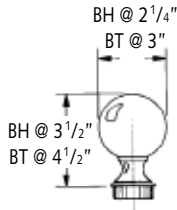

- BH-437 - 1 1/2"
- BT-437 - 2"

### Wall Flange

Tubing fits inside flange. To secure connection, apply adhesive to inside flange sleeve and insert tubing.

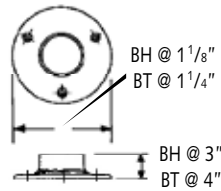
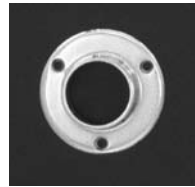

- BH-428 - 1 1/2"
- BT-428 - 2"

### Adjustable Angle Flange

Tubing slips over mounting insert. To secure connections, apply adhesive to inside of tubing end and slip over insert.

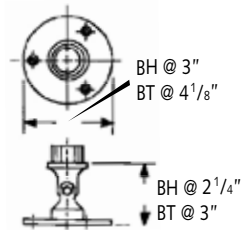

- BH-428A - 1 1/2"
- BT-428A - 2"

### Floor Flange

Tubing fits inside flange. To secure connection, apply adhesive to inside flange sleeve and insert tubing.

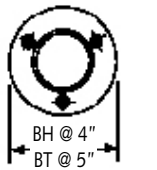
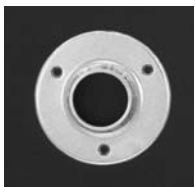

- BH-429 - 1 1/2"
- BT-429 - 2"

### Heavy Duty Floor Flange

Tubing fits inside flange. To secure connection, apply adhesive to inside flange sleeve and insert tubing.



- BH-430 - 1 1/2"
- BT-430 - 2"

### Floor Cover Plate

Decorative flange with no screw holes. Apply adhesive to tubing so the collar will adhere to it.

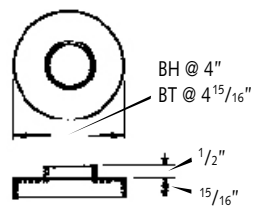

- BH-429C - 1 1/2"
- BT-429C - 2"

### Iron Flange

Reinforcing post provides extra stability inside brass tubing. Use in conjunction with 429C.

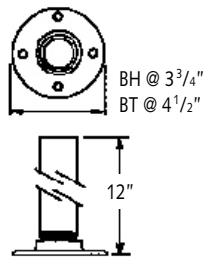

- BH-429IF - 1 1/2"
- BT-429IF - 2"

### Socket & Cap for Uncarpeted Floor

Allows removal of rail from concrete floor. Requires concrete floor.

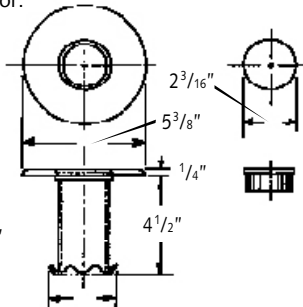

- BT-429S - 2"

### Brass Tubing

Bright finish. 12' Maximum length. Can be custom cut.

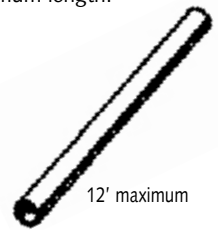

- BH-106BB - 1 1/2"
- BT-106BB - 2"

### Socket & Cap for Carpeted Floor

Allows removal of rail from concrete floor. Requires concrete floor.

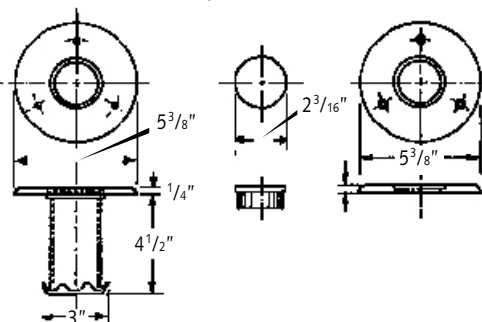

- BT-429SC - 2"

### Angle Adapter/Collar

Used to create proper angle on stair railing. Position adapter at angle required on ball fitting (can be used from 90° - 180°) and attach with machine screws provided by manufacturer.

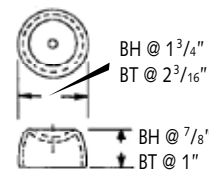
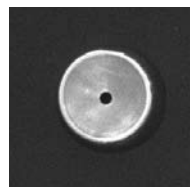

- BH-427 - 1 1/2"
- BT-427 - 2"

### Adjustable Saddle

Tubing slips over insert. To secure connection, apply adhesive to inside of tubing and slip over insert.

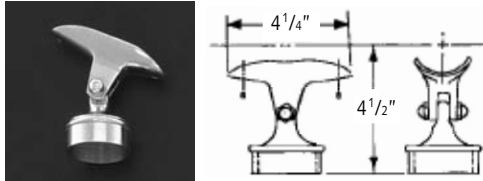

**BT-432** - 2"

### 2" to 1" Tubing Adapter

Connection adapts 2" O.D. tubing to 1" O.D. perpendicular. Position adapter at angle required on 2" tubing and attach with machine screw provided by manufacturer. 1" tubing fits inside adapter.

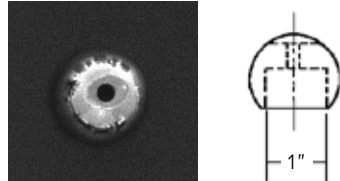

**BT-434** - 2"

### Diameter Ball

Performs same function as a cap nut to cover 3/16" exposed threaded rod, but in a decorative manner.

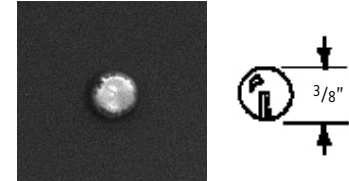

**BU-448**

### Stemware Rack

Provides 10 lanes to hold wine glasses.

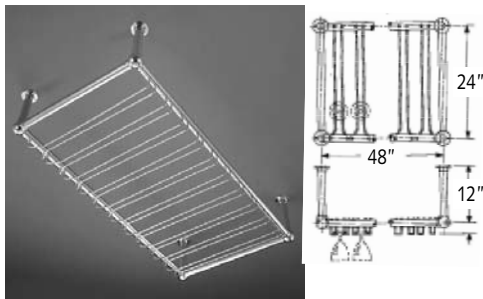

**BH-447** - 1 1/2"

### Glass Channel

Used to frame glass panels with brass tubing for salad bar sneeze guards, booth privacy panels, etc. Can fit any size tubing and accommodates glass 3/8" thick. Can be used with or without 446.

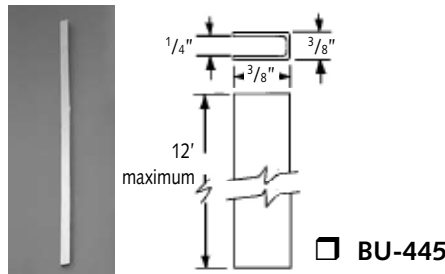

**BU-445**

### Glass Clip

Can be used with or without 445. Attaches to tubing and removable panel tightens against glass. Accommodates glass 1/4" thick.

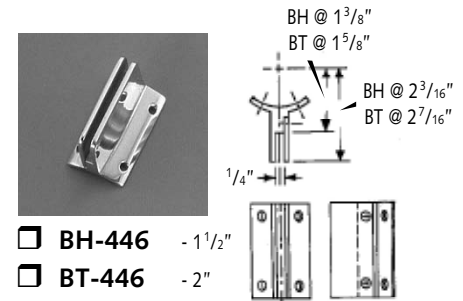

**BH-446** - 1 1/2"

**BT-446** - 2"

### Curtain Ring

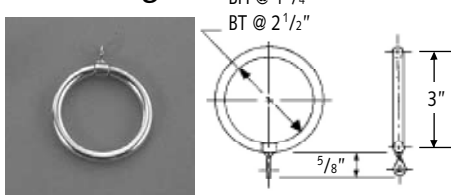

**BH-435** - 1 1/2"

**BT-435** - 2"

### Service Bar Rail

Separates area of bar that is not to be used by customers.

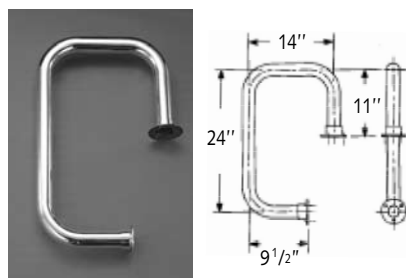

**BH-458** - 1 1/2"

**BT-458** - 2"

### Waitress Station

Separates area of bar that is not to be used by customers.

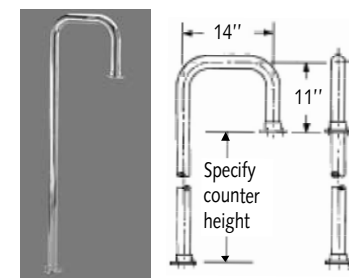

**BH-459** - 1 1/2"

**BT-459** - 2"

### Crowd Control Post

Useful anywhere queues form. Easy set-up and dismantling allows instant adaptation to fluctuations in crowd size.

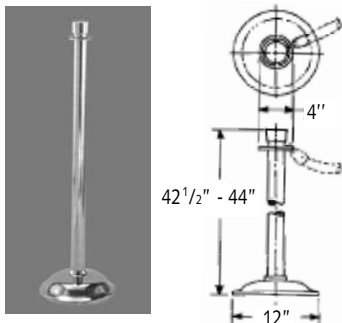

**BT-460** - 2"

### Snap Rope End

Screws secure ends of rope inside fittings.

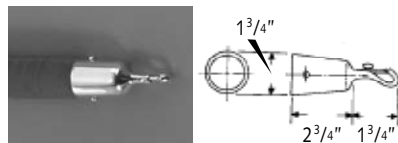

**BH-460B** - 1 1/2"

### Velour Rope

Gold, green, blue and brown. Standard length is 7' between posts; shorter lengths can be custom cut (indicate post-to-post dimension only, as TSM will allow for slack.) Rope fits snugly in sleeve of 460B.

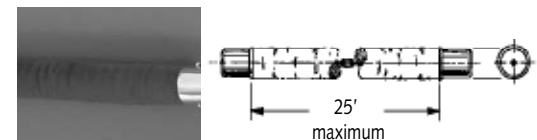

**BH-460C** - 1 1/2"

**Internal Dowel & Adhesive**

Used to connect component pieces; one required for every hairline joint. Adhesive sealant supplied.

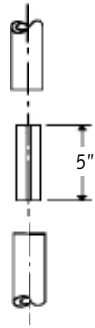

- BH-490 - 1 1/2"
- BT-490 - 2"

**90° Mitered Corner Elbow**

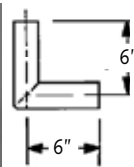

- BH-491 - 1 1/2"
- BT-491 - 2"

**90° Mitered Radius Bend Elbow**

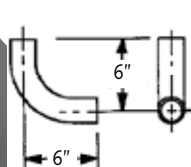

- BH-493 - 1 1/2"
- BT-493 - 2"

**Custom Radius Bend**

Custom angles and radii are available.

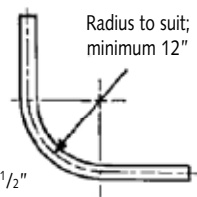

- BH-494 - 1 1/2"
- BT-494 - 2"



**Architectural Specification**

*Note:* B-400 Series Components should not be specified in lieu of grab bars or any other support accessory.

Railing Components \_\_\_\_\_ [fill in model names and numbers] shall be brass with a bright polished finish. Formed construction shall fit \_\_\_\_\_ [1 1/2" or 2"] O.D. tubing (38 or 51mm). Tubing shall be \_\_\_\_\_ [1 1/2" or 2"] O.D.

**Brass Components shall be Models \_\_\_\_\_ as manufactured by Tubular Specialties Manufacturing, 13011 South Spring Street, Los Angeles, California 90061, tel (800)Grab Bar.**



**Materials/Workmanship**

- Components** Bright finish brass. Formed construction. Fit 1 1/2" and 2" (38 & 51mm) O.D. tubing.
- Tubing** Bright finish brass, 1 1/2" and 2" (38 & 51mm) O.D.



**Installation**

1. In-wall backing is required. TSM recommends supports every 48" for upright rails and every 36" for footrails.
2. It is important to comply with local codes in mounting railings, for the national codes vary widely in their recommendations (from 30"- 38" above floor level).
3. Align brackets with tubing, then use flanges as a template to pinpoint mounting hole placement. Pre-drill pilot holes and lubricate screws provided by TSM with soap. Attach tubing to brackets using set screws or adhesive provided by TSM.
4. While TSM provides 2" stainless steel wood screws with Series B-400, it is the installer's responsibility to select fasteners that are appropriate for the wall condition and application. Mounting holes in flanges are countersunk.
5. **For set screw connections:** Drill through component and tubing with bit and thread tubing or component (whichever is closest) with tap.
6. **For adhesive connections:** Apply bead inside female component openings and insert dowels to form a hairline joint. Adhesive can be used in conjunction with set screws for extra strength.
7. **401 Bar Wall Bracket:** Top flange has 5/16"-18 threaded mounting hole that requires either access from back or a 3/16" pilot hole about 1" deep to be used with a hanger bolt (supplied by others).
8. **427 Angle Adapter/Collar:** Position adapter at angle required on ball fitting (can be used from 90 to 180°) and attach with machine screws provided by manufacturer.
9. **429C Floor Cover Plate:** The 429C is a collared cover plate with no screw holes. To install, place 429-C on the cement while it is wet. For a dry installation, apply epoxy, silicon adhesive or caulking material to the bottom rim of the plate. Apply epoxy, silicon adhesive or caulking material to tubing so the collar will adhere to it.
10. **429IF Iron Flange:** The 429C slips over the 429IF Iron Flange. Apply epoxy, silicon adhesive or caulking material to tubing so the collar on the 429C will adhere to it.
11. **429S, 429SC Socket & Cap for Uncarpeted and Carpeted Floors:** Requires concrete floor. Drill out a 3" area and fill in the concrete around it. Lugs welded onto brass vertical prevent the entire socket from coming out of the concrete after it's set
12. **434 2" to 1" Tubing Adapter:** Connection adapts 2" O.D. tubing to 1" O.D. perpendicular. Position adapter at angle required on 2" tubing and attach with machine screw provided by manufacturer. 1" tubing fits inside adapter.
13. **445 Glass Channel:** Can fit any size tubing and accommodate glass 1/4" thick. Can be used with or without 446. TSM recommends that glass channel be attached in the field with set screws. Drill holes through the tubing and channel approximately every 12", then tap all tubing holes where the channel is to be attached. Do not tap the channel, or it will not be possible to tighten the tubing and channel together. Tap the tubing only! Align the channel and tubing holes and insert set screws provided by TSM. Do not overtighten or the threads in the tubing will strip. A second method for attaching glass channel is to instruct the factory to weld the channel to the tubing. This is more costly than set screws and requires precise drawings detailing where the channel is to be attached. TSM welds the channel to the tubing approximately every 12" on both sides.
14. **446 Glass Clip:** Same use as 445. Attaches to tubing and removable panel tightens against glass. Accommodates glass 1/4" thick. Can be used with or without 445. Secure to tubing using four 1/4" x 8/32 pan head brass machine screws provided by TSM. Remove side panel of clip, insert glass and tighten panel to hold glass securely.
15. All railing systems should be inspected periodically to make sure their attachment to the wall is not loosening.



**Guarantee**

TSM Series B-400 Brass Component Railing System is guaranteed against defects in workmanship and material for one year from shipping date.